

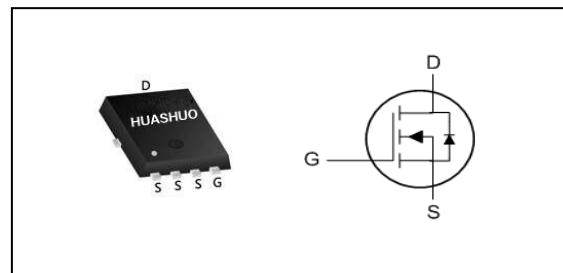
**N-Ch 100V Fast Switching MOSFETs**
**Description**

The HSBA0048 is the high cell density trench N-ch MOSFETs, which provide excellent  $R_{DS(ON)}$  and gate charge for most of the Synchronous Rectification for AC/DC Quick Charger.

- 100% EAS Guaranteed
- LOW  $R_{DS(ON)}$
- Low Gate Charge
- RoHs and Halogen-Free Compliant

**Product Summary**

$V_{DS}$	100	V
$R_{DS(ON),TYP}$	6.6	$m\Omega$
$I_D$	48	A

**PRPAK5X6 Pin Configuration**

**Absolute Maximum Ratings**

Symbol	Parameter	Rating	Units
$V_{DS}$	Drain-Source Voltage	100	V
$V_{GS}$	Gate-Source Voltage	$\pm 20$	V
$I_D@T_C=25^\circ C$	Continuous Drain Current <sup>1,6</sup>	48	A
$I_D@T_C=70^\circ C$	Continuous Drain Current <sup>1,6</sup>	48	A
$I_{DM}$	Pulsed Drain Current <sup>2</sup>	140	A
EAS	Single Pulse Avalanche Energy <sup>3</sup>	61	mJ
$I_{AS}$	Avalanche Current	35	A
$P_D@T_C=25^\circ C$	Total Power Dissipation <sup>4</sup>	108	W
$T_{STG}$	Storage Temperature Range	-55 to 150	$^\circ C$
$T_J$	Operating Junction Temperature Range	-55 to 150	$^\circ C$

**Thermal Data**

Symbol	Parameter	Typ.	Max.	Unit
$R_{\theta JA}$	Thermal Resistance Junction-Ambient <sup>1</sup> ( $t \leq 10s$ )	---	25	$^\circ C/W$
	Thermal Resistance Junction-Ambient <sup>1</sup>	---	55	$^\circ C/W$
$R_{\theta JC}$	Thermal Resistance Junction-Case <sup>1</sup>	---	1.15	$^\circ C/W$

**N-Ch 100V Fast Switching MOSFETs**
**Electrical Characteristics (T<sub>J</sub>=25 °C, unless otherwise noted)**

Symbol	Parameter	Conditions	Min.	Typ.	Max.	Unit
BV <sub>DSS</sub>	Drain-Source Breakdown Voltage	V <sub>GS</sub> =0V, I <sub>D</sub> =250uA	100	---	---	V
R <sub>DS(ON)</sub>	Static Drain-Source On-Resistance <sup>2</sup>	V <sub>GS</sub> =10V, I <sub>D</sub> =13.5A	---	6.6	8	mΩ
	Static Drain-Source On-Resistance <sup>2</sup>	V <sub>GS</sub> =4.5V, I <sub>D</sub> =11.5A	---	8.7	10.5	
V <sub>GS(th)</sub>	Gate Threshold Voltage	V <sub>GS</sub> =V <sub>DS</sub> , I <sub>D</sub> =250uA	1.2	---	2.3	V
I <sub>DSS</sub>	Drain-Source Leakage Current	V <sub>DS</sub> =80V, V <sub>GS</sub> =0V, T <sub>J</sub> =25°C	---	---	1	uA
		V <sub>DS</sub> =80V, V <sub>GS</sub> =0V, T <sub>J</sub> =55°C	---	---	5	
I <sub>GSS</sub>	Gate-Source Leakage Current	V <sub>GS</sub> =±20V, V <sub>DS</sub> =0V	---	---	±100	nA
g <sub>fs</sub>	Forward Transconductance	V <sub>DS</sub> =5V, I <sub>D</sub> =20A	---	85	---	S
Q <sub>g</sub>	Total Gate Charge (10V)	V <sub>DS</sub> =50V, V <sub>GS</sub> =10V, I <sub>D</sub> =13.5A	---	45	---	nC
Q <sub>g</sub>	Total Gate Charge (4.5V)		---	19.3	---	
Q <sub>gs</sub>	Gate-Source Charge		---	9.5	---	
Q <sub>gd</sub>	Gate-Drain Charge		---	4.8	---	
T <sub>d(on)</sub>	Turn-On Delay Time	V <sub>DD</sub> =50V, V <sub>GS</sub> =10V, R <sub>G</sub> =3Ω, I <sub>D</sub> =13.5A	---	10	---	ns
T <sub>r</sub>	Rise Time		---	6.5	---	
T <sub>d(off)</sub>	Turn-Off Delay Time		---	45	---	
T <sub>f</sub>	Fall Time		---	7.5	---	
C <sub>iss</sub>	Input Capacitance	V <sub>DS</sub> =50V, V <sub>GS</sub> =0V, f=1MHz	---	3320	---	pF
C <sub>oss</sub>	Output Capacitance		---	605	---	
C <sub>rss</sub>	Reverse Transfer Capacitance		---	20	---	

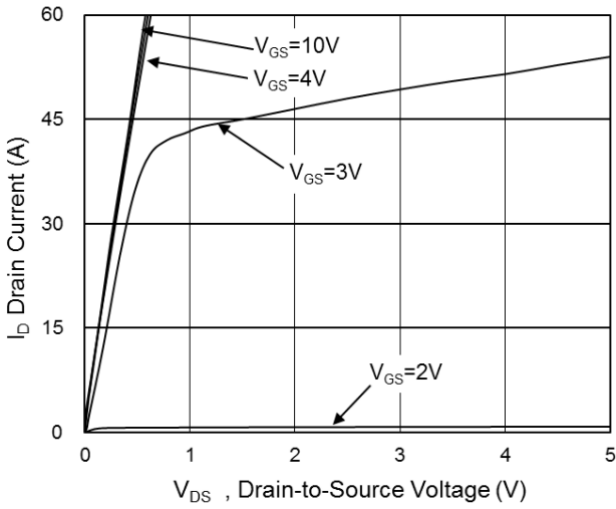
**Diode Characteristics**

Symbol	Parameter	Conditions	Min.	Typ.	Max.	Unit
I <sub>S</sub>	Continuous Source Current <sup>1,5,6</sup>	V <sub>G</sub> =V <sub>D</sub> =0V, Force Current	---	---	48	A
V <sub>SD</sub>	Diode Forward Voltage <sup>2</sup>	V <sub>GS</sub> =0V, I <sub>S</sub> =1A, T <sub>J</sub> =25°C	---	---	1.1	V
t <sub>rr</sub>	Reverse Recovery Time	I <sub>F</sub> =13.5A, di/dt=100A/μs,	---	33	---	nS
Q <sub>rr</sub>	Reverse Recovery Charge	T <sub>J</sub> =25°C	---	150	---	nC

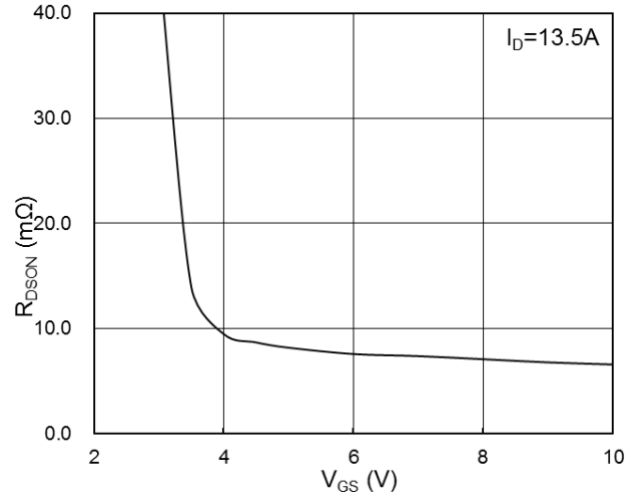
Note :

- 1.The data tested by surface mounted on a 1 inch<sup>2</sup> FR-4 board with 2OZ copper.
- 2.The data tested by pulsed, pulse width ≤ 300us, duty cycle ≤ 2%
- 3.The EAS data shows Max. rating. The test condition is V<sub>DD</sub>=25V, V<sub>GS</sub>=10V, L=0.3mH, I<sub>AS</sub>=35A
- 4.The power dissipation is limited by 150°C junction temperature
- 5.The data is theoretically the same as I<sub>D</sub> and I<sub>DM</sub>, in real applications, should be limited by total power dissipation.
- 6.The maximum current rating is package limited.

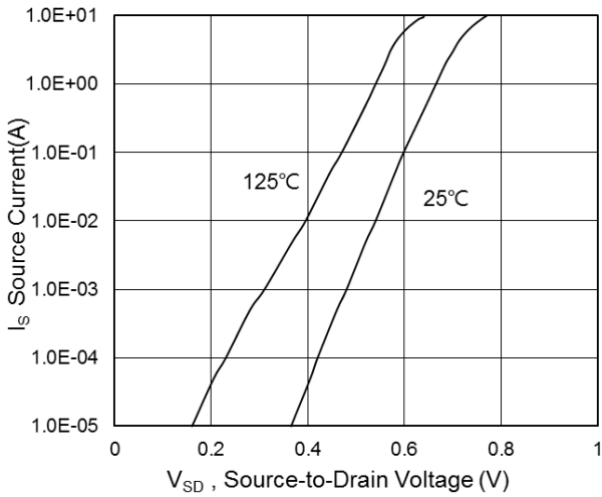
**Typical Characteristics**



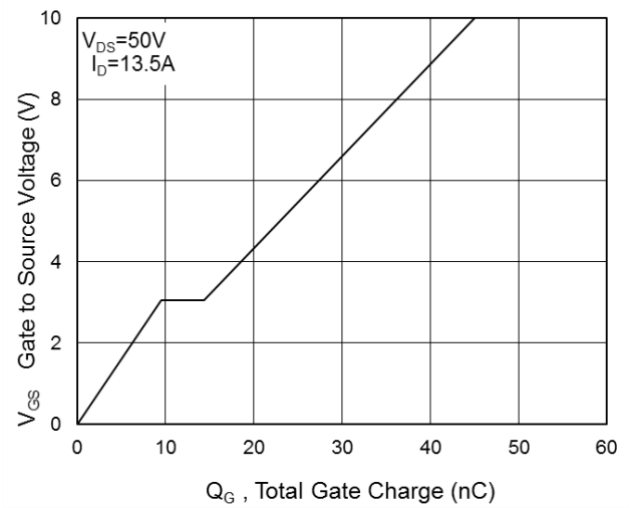
**Fig.1 Typical Output Characteristics**



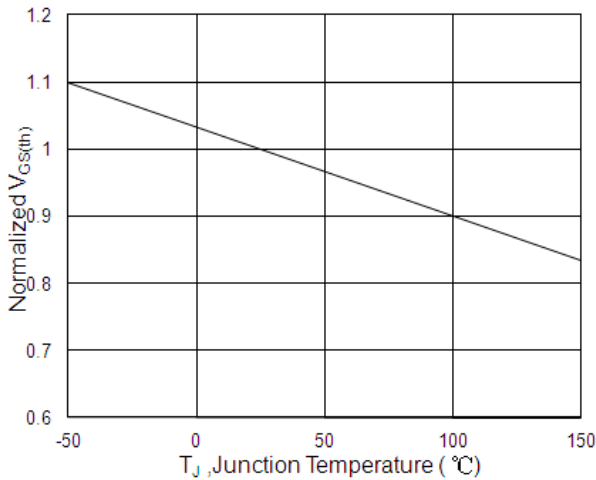
**Fig.2 On-Resistance vs G-S Voltage**



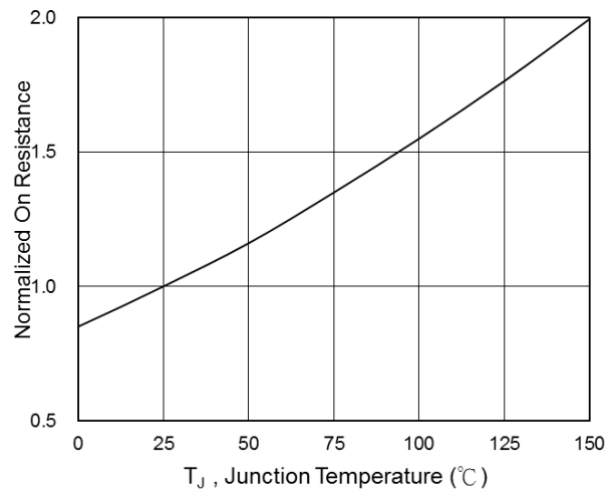
**Fig.3 Source-Drain Forward Characteristics**



**Fig.4 Gate-Charge Characteristics**

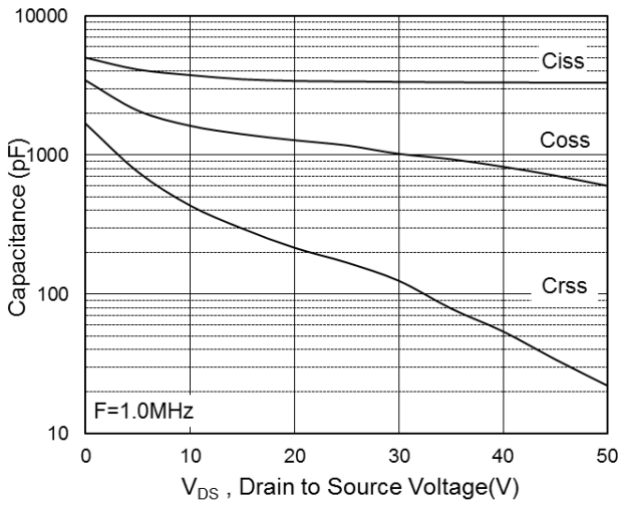


**Fig.5 Normalized  $V_{GS(th)}$  vs  $T_J$**

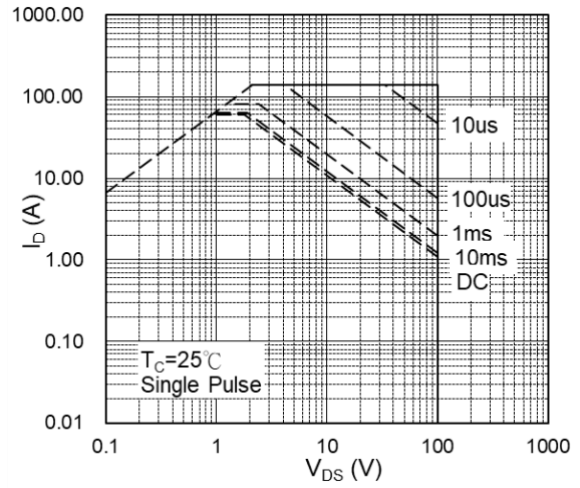


**Fig.6 Normalized  $R_{DS(on)}$  vs  $T_J$**

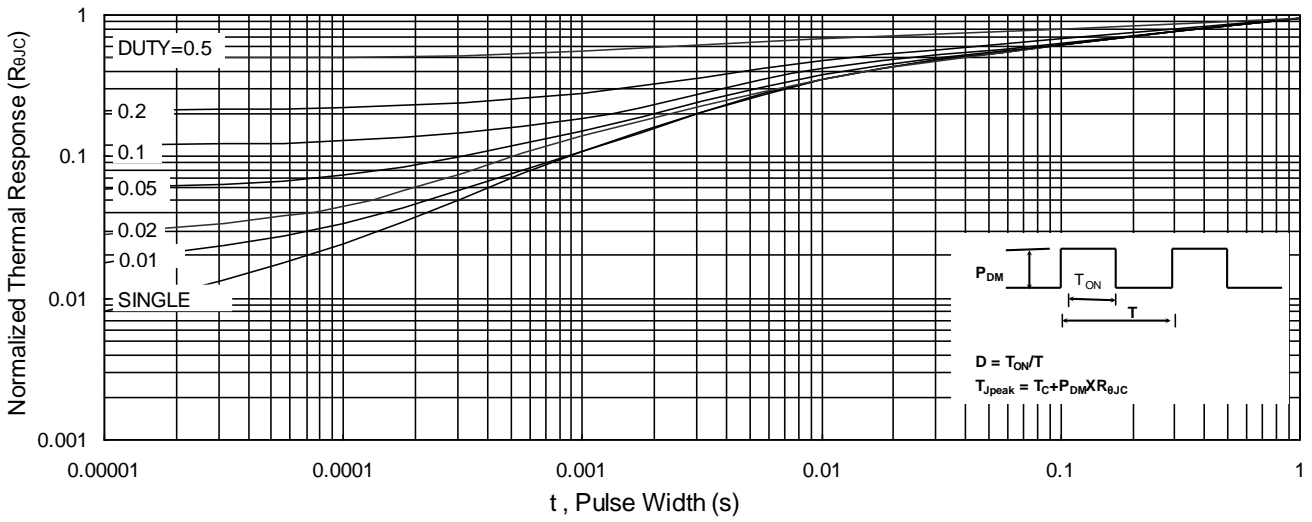
**N-Ch 100V Fast Switching MOSFETs**



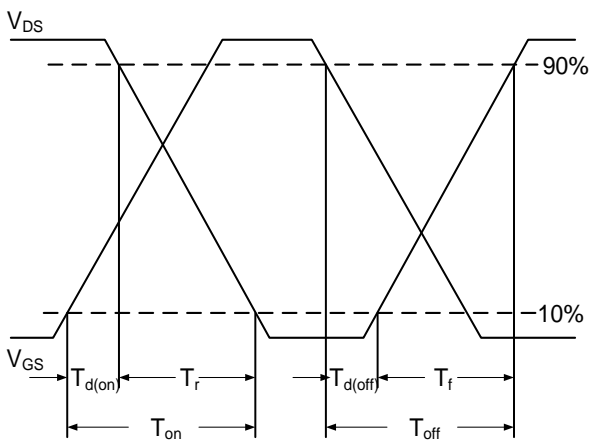
**Fig.7 Capacitance**



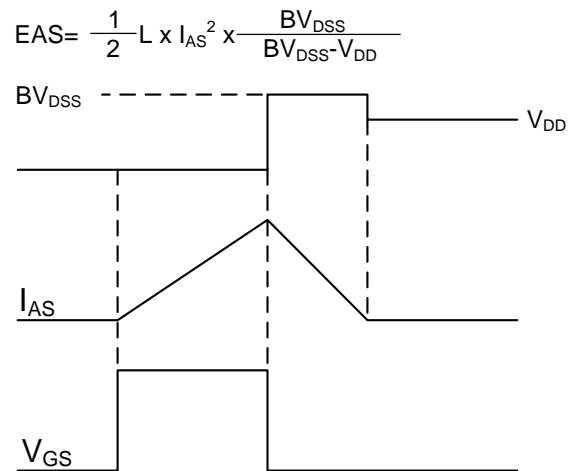
**Fig.8 Safe Operating Area**



**Fig.9 Normalized Maximum Transient Thermal Impedance**

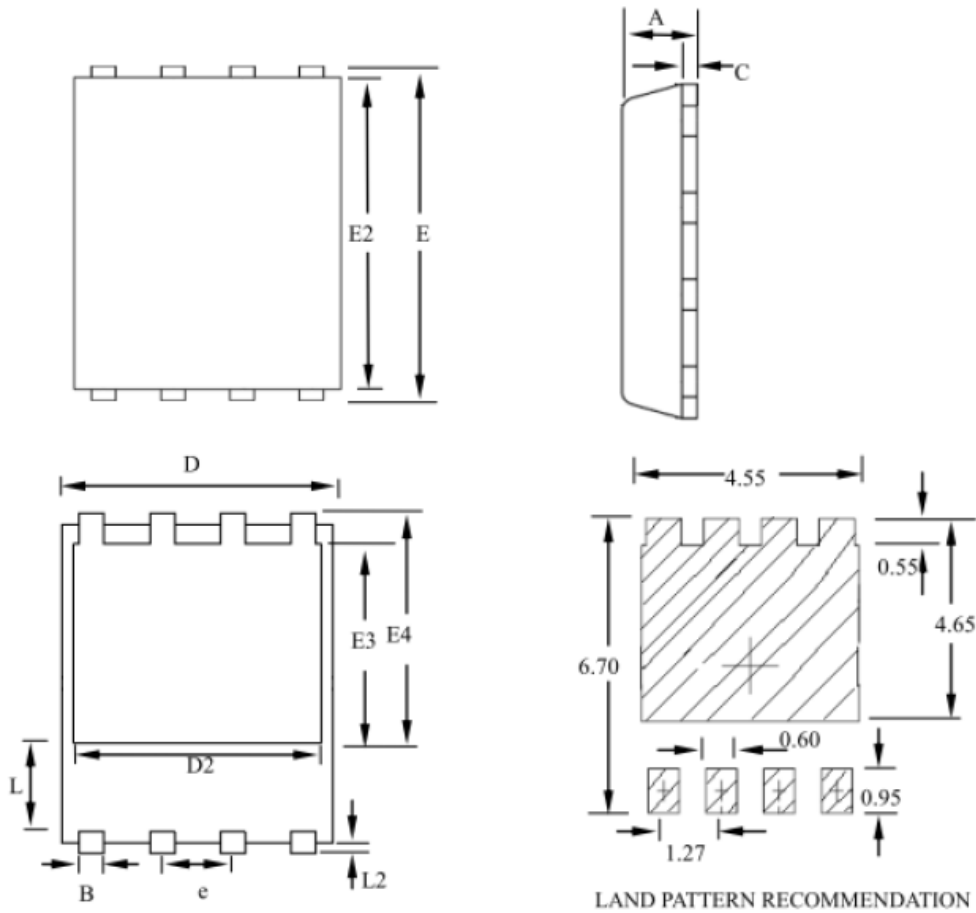


**Fig.10 Switching Time Waveform**



**Fig.11 Unclamped Inductive Switching Waveform**

## PRPAK5X6 Package Outline Dimensions



SYMBOLS	MILLIMETERS			INCHES		
	MIN	NOM	MAX	MIN	NOM	MAX
A	0.80	--	1.20	0.031	--	0.047
B	0.30	--	0.51	0.012	--	0.020
C	0.15	--	0.35	0.006	--	0.014
D	4.80	--	5.30	0.189	--	0.209
D2	3.61	--	4.35	0.142	--	0.171
E	5.90	--	6.35	0.232	--	0.250
E2	5.42	--	5.90	0.213	--	0.232
E3	3.23	--	3.90	0.127	--	0.154
E4	3.69	--	4.55	0.145	--	0.179
L	0.61	--	1.80	0.024	--	0.071
L2	0.05	--	0.36	0.002	--	0.014
e	--	1.27	--	--	0.050	--