

Description

The HSP6016A is the high cell density trenched N-ch MOSFETs, which provide excellent RDSON and gate charge for most of the synchronous buck converter applications.

The HSP6016A meet the RoHS and Green Product requirement, 100% EAS guaranteed with full function reliability approved.

- Super Low Gate Charge
- 100% EAS Guaranteed
- Green Device Available
- Excellent CdV/dt effect decline
- Advanced high cell density Trench technology

Product Summary

V_{DS}	60	V
$R_{DS(ON),typ}$	9	m Ω
I_D	60	A

TO220 Pin Configuration

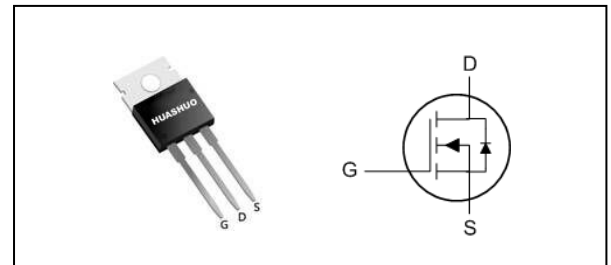

Absolute Maximum Ratings

Symbol	Parameter	Rating	Units
V_{DS}	Drain-Source Voltage	60	V
V_{GS}	Gate-Source Voltage	± 20	V
$I_D@T_C=25^\circ C$	Continuous Drain Current, $V_{GS} @ 10V^1$	60	A
$I_D@T_C=100^\circ C$	Continuous Drain Current, $V_{GS} @ 10V^1$	38	A
$I_D@T_A=25^\circ C$	Continuous Drain Current, $V_{GS} @ 10V^1$	9.2	A
$I_D@T_A=70^\circ C$	Continuous Drain Current, $V_{GS} @ 10V^1$	7.5	A
I_{DM}	Pulsed Drain Current ²	135	A
EAS	Single Pulse Avalanche Energy ³	73	mJ
I_{AS}	Avalanche Current	38	A
$P_D@T_C=25^\circ C$	Total Power Dissipation ⁴	86.8	W
$P_D@T_A=25^\circ C$	Total Power Dissipation ⁴	2	W
T_{STG}	Storage Temperature Range	-55 to 150	$^\circ C$
T_J	Operating Junction Temperature Range	-55 to 150	$^\circ C$

Thermal Data

Symbol	Parameter	Typ.	Max.	Unit
$R_{\theta JA}$	Thermal Resistance Junction-Ambient ¹	---	62	$^\circ C/W$
$R_{\theta JC}$	Thermal Resistance Junction-Case ¹	---	1.44	$^\circ C/W$



Electrical Characteristics (T_J=25 °C, unless otherwise noted)

Symbol	Parameter	Conditions	Min.	Typ.	Max.	Unit
B _{VDSS}	Drain-Source Breakdown Voltage	V _{GS} =0V, I _D =250uA	60	---	---	V
ΔB _{VDSS} /ΔT _J	B _{VDSS} Temperature Coefficient	Reference to 25°C, I _D =1mA	---	0.052	---	V/°C
R _{DS(ON)}	Static Drain-Source On-Resistance ²	V _{GS} =10V, I _D =30A	---	9	12	mΩ
V _{GS(th)}	Gate Threshold Voltage	V _{GS} =V _{DS} , I _D =250uA	2	---	5	V
ΔV _{GS(th)}	V _{GS(th)} Temperature Coefficient		---	-5.76	---	mV/°C
I _{DSS}	Drain-Source Leakage Current	V _{DS} =48V, V _{GS} =0V, T _J =25°C	---	---	1	uA
		V _{DS} =48V, V _{GS} =0V, T _J =55°C	---	---	5	
I _{GSS}	Gate-Source Leakage Current	V _{GS} =±20V, V _{DS} =0V	---	---	±100	nA
g _{fs}	Forward Transconductance	V _{DS} =5V, I _D =30A	---	42	---	S
R _g	Gate Resistance	V _{DS} =0V, V _{GS} =0V, f=1MHz	---	1.5	---	Ω
Q _g	Total Gate Charge (4.5V)	V _{DS} =48V, V _{GS} =4.5V, I _D =15A	---	33	---	nC
Q _{gs}	Gate-Source Charge		---	10.5	---	
Q _{gd}	Gate-Drain Charge		---	9.9	---	
T _{d(on)}	Turn-On Delay Time	V _{DD} =30V, V _{GS} =10V, R _G =3.3Ω, I _D =15A	---	10.4	---	ns
T _r	Rise Time		---	9.2	---	
T _{d(off)}	Turn-Off Delay Time		---	63	---	
T _f	Fall Time		---	4.8	---	
C _{iss}	Input Capacitance	V _{DS} =15V, V _{GS} =0V, f=1MHz	---	2188	---	pF
C _{oss}	Output Capacitance		---	260	---	
C _{rss}	Reverse Transfer Capacitance		---	167	---	

Diode Characteristics

Symbol	Parameter	Conditions	Min.	Typ.	Max.	Unit
I _S	Continuous Source Current ^{1,5}	V _G =V _D =0V, Force Current	---	---	60	A
I _{SM}	Pulsed Source Current ^{2,5}		---	---	135	A
V _{SD}	Diode Forward Voltage ²	V _{GS} =0V, I _S =A, T _J =25°C	---	---	1.2	V
t _{rr}	Reverse Recovery Time	I _F =15A, dI/dt=100A/μs, T _J =25°C	---	18	---	nS
Q _{rr}	Reverse Recovery Charge		---	14	---	nC

Note :

- 1.The data tested by surface mounted on a 1 inch² FR-4 board with 2OZ copper.
- 2.The data tested by pulsed, pulse width ≤ 300us, duty cycle ≤ 2%
- 3.The EAS data shows Max. rating. The test condition is V_{DD}=25V, V_{GS}=10V, L=0.1mH, I_{AS}=38A
- 4.The power dissipation is limited by 150°C junction temperature
- 5.The data is theoretically the same as I_D and I_{DM}, in real applications, should be limited by total power dissipation.



Typical Characteristics

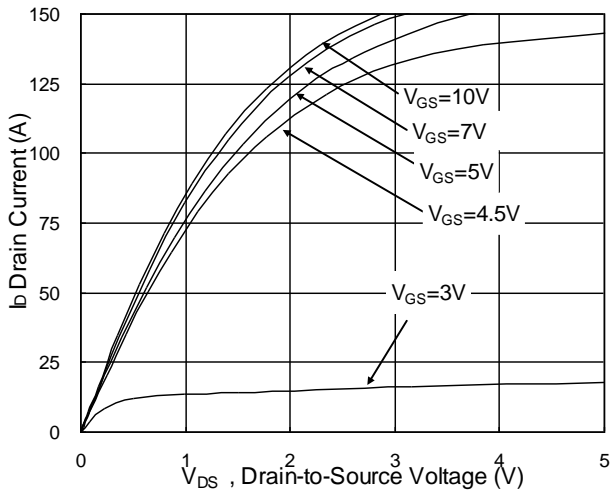

Fig.1 Typical Output Characteristics

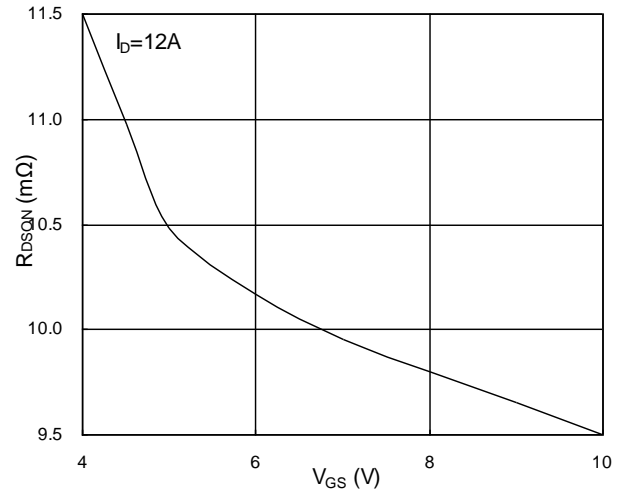

Fig.2 On-Resistance v.s Gate-Source

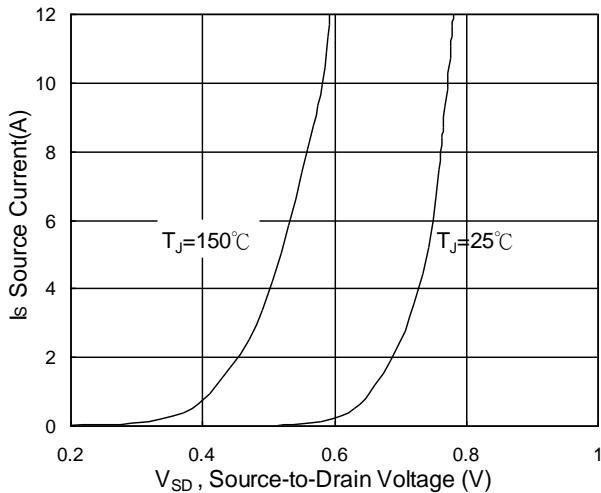

Fig.3 Forward Characteristics of Reverse

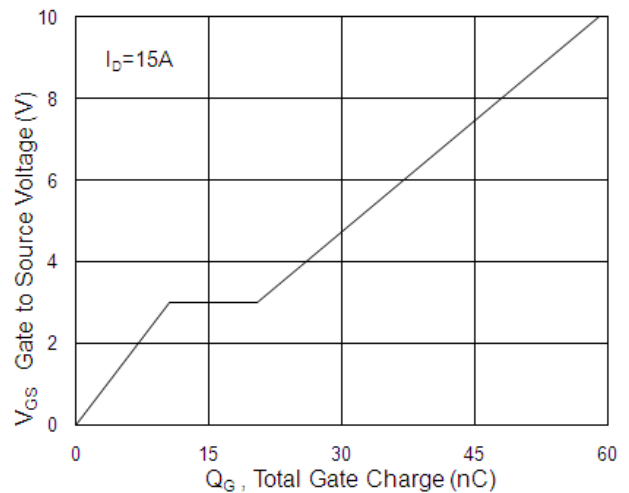

Fig.4 Gate-Charge Characteristics

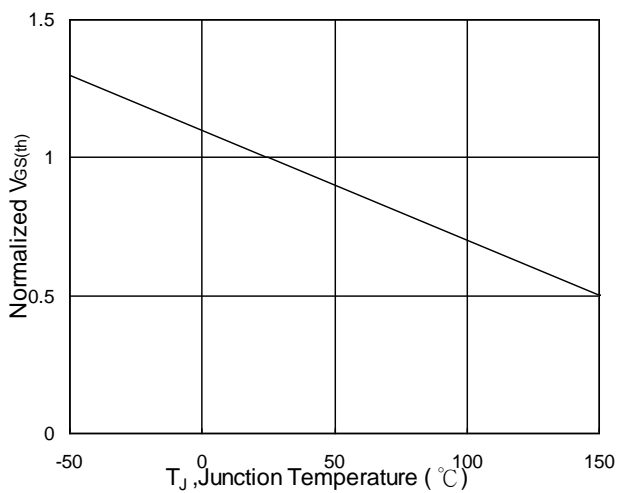

Fig.5 Normalized $V_{GS(th)}$ v.s T_J

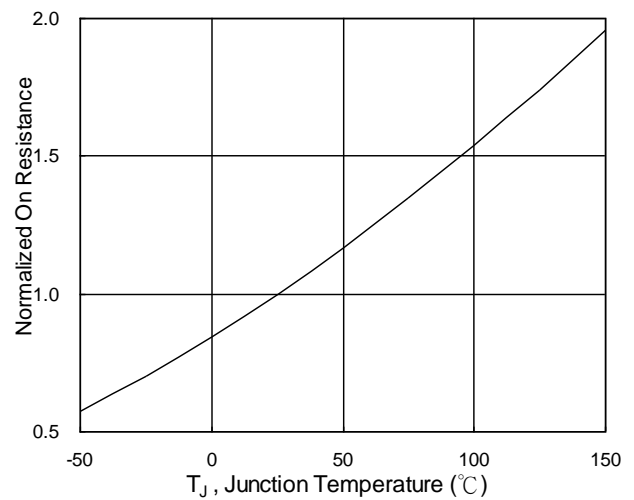

Fig.6 Normalized $R_{DS(on)}$ v.s T_J

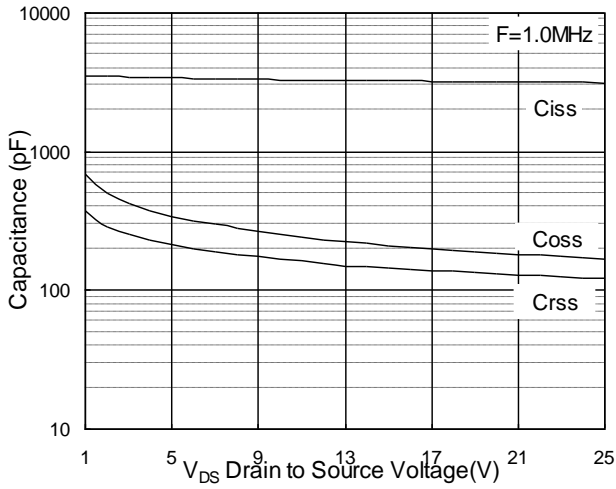

Fig.7 Capacitance

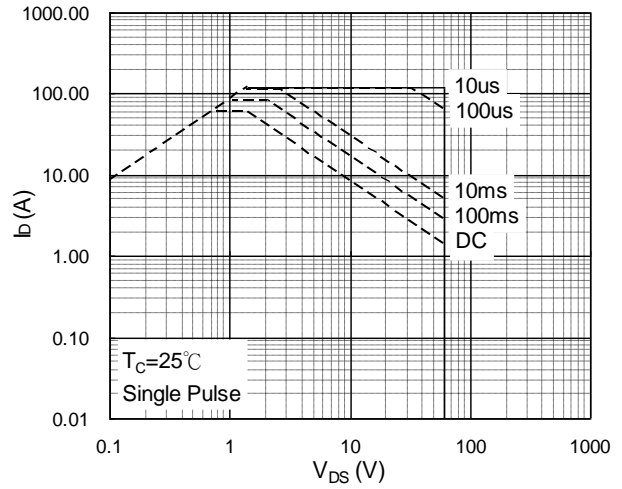

Fig.8 Safe Operating Area

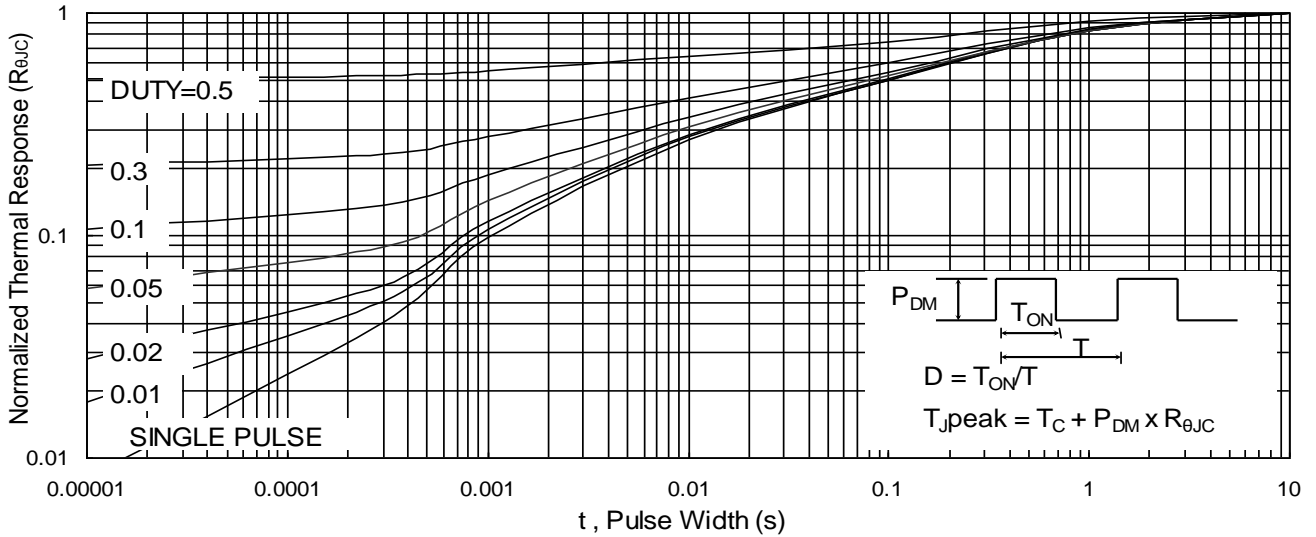

Fig.9 Normalized Maximum Transient Thermal Impedance

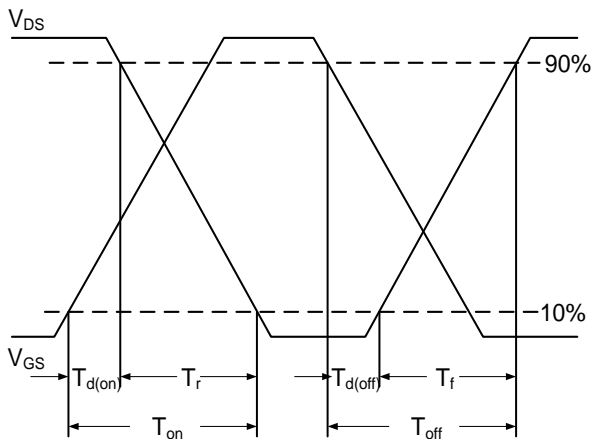

Fig.10 Switching Time Waveform

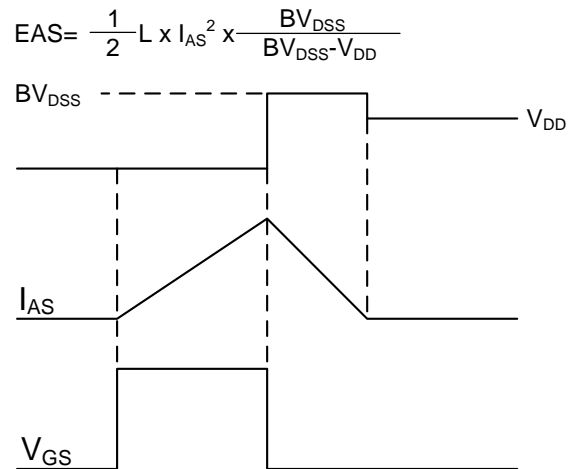

Fig.11 Unclamped Inductive Switching